



smart
architectural aluminium

Visoglide Plus

Visoglide Plus offers the same contemporary styling and robust performance associated with the system whilst delivering superior thermal performance.

- U Value 1.6 W/m²K
- Air Class 3, 600Pa
- Water Class 7a, 300Pa
- Wind Class AE, 2400Pa
- Inline sliding or lift & slide options
- Colour matched accessories now available
speak with your supplier for details
- British Standard Kitemarked system achieving:
KM 530838 PAS 24:2012

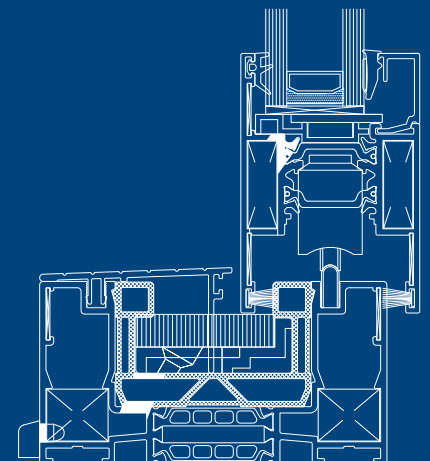
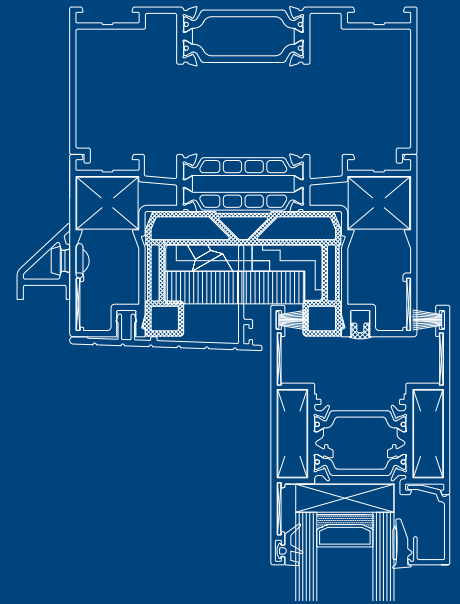



Project

Said Business School

Egrove Park, Kennington Road, Oxford OX1 5NY

Architect

Dixon Jones

2-3 Noel Road, Hanover Yard, London N1 8YA

Main Contractor

Chalegrove Properties Ltd

243 Knightsbridge, London, SW7 1DN

Summary

The second phase of Oxford University's Said Business School was completed in July 2012 and officially opened in February 2013. A striking feature of the building's external façade is an 8.2 metre run of Smart Visoglide sliding doors, installed in an unusual 'zigzag' formation which makes the internal space extremely flexible, allowing easy movement to a large paved terrace.

Elsewhere, Visoglide doors have also been used to add a feeling of light and space to the meeting and dining rooms, some with access to external and others to internal balcony areas. Continuing the design theme, the Visoline casement and tilt & turn windows and single and Smart Wall double doors were installed where possible without mullions or transoms to accentuate the systems' slim lines. Finally an imposing Smart Wall double door leads students, staff and visitors from the building's reception area to a central staircase and the impressive facilities beyond.



Examples of Typical Sections

Visoglide Plus Inline Sliding Door

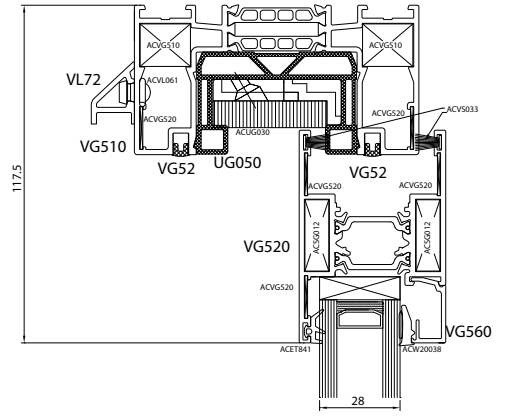
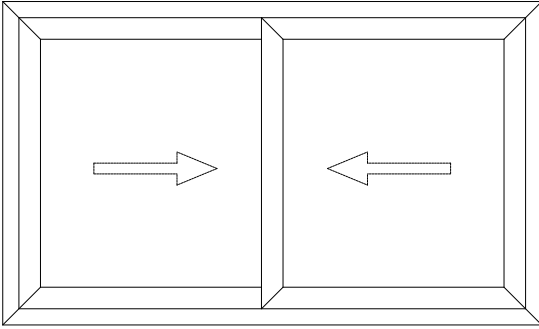

Vertical section

Visoglide Plus Lift and Slide Door

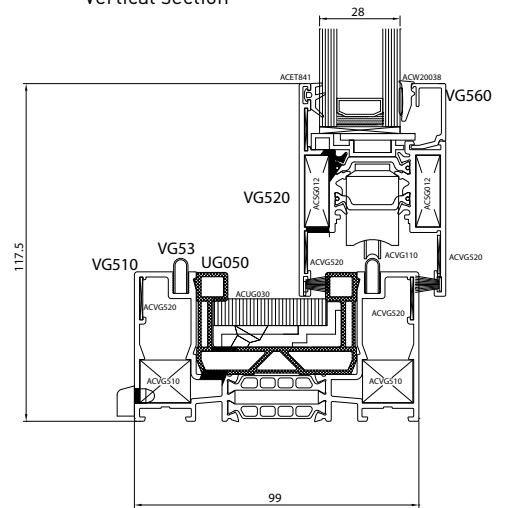
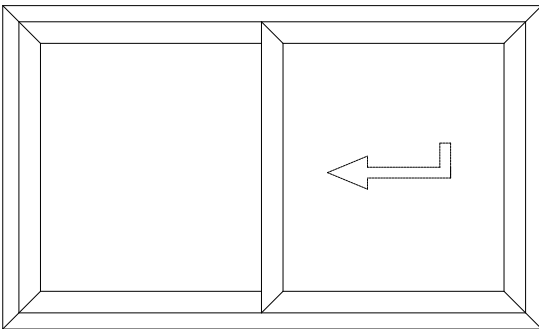

Horizontal section through inline sliding door

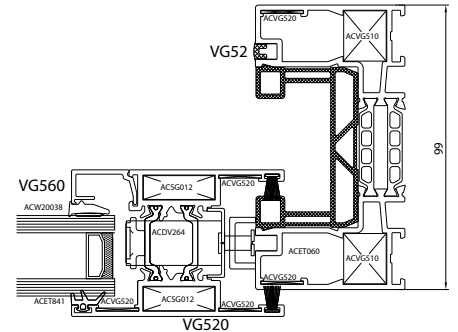
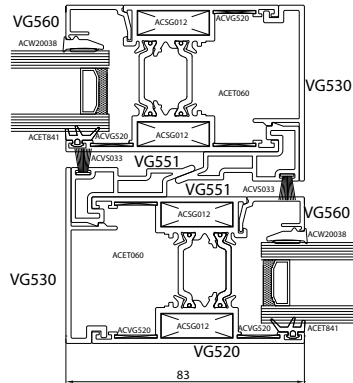
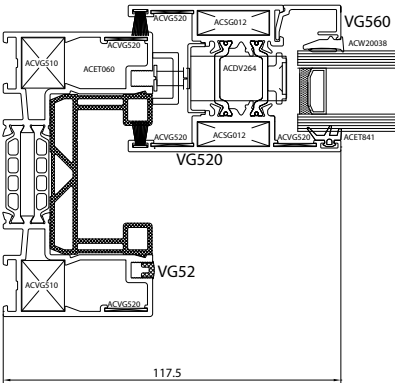

Horizontal section through lift and slide door

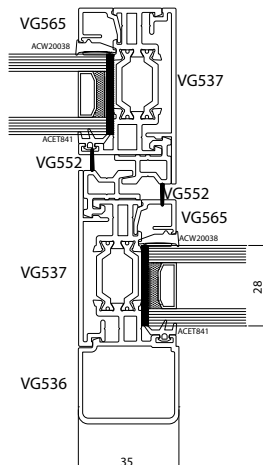
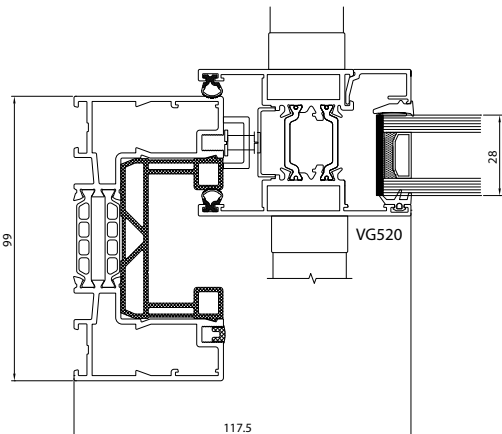

Slimline mullion option for inline and lift and slide door

Visoglide Plus

This adaptable system is suitable for use as either sliding commercial entrances where large opening apertures are required, or as dynamic residential sliding doors that maximise light and give stunning unimpeded views.

Visoglide Plus profiles have been designed to improve both strength and weather resistance. All main sections feature an extended polyamide thermal break that allows Visoglide Plus to achieve a U Value of 1.6 W/m²K when installed with a suitable sealed unit.

Visoglide Plus doors are available in both single and dual colour in wide choice of standard and non-standard finishes including Smart's unique Sensations range of textured colours.

The system is also suitable for use with auto slide opening mechanisms*.



Technical Performance

U Value	1.6 W/m ² K (When using a 1.0 W/m ² K centre pane)
Air	Class 3, 600Pa
Water	Class 7a, 300Pa
Wind	Class AE, 2400Pa
Glass	up to 38mm
Dual Colour	Yes
Security	Multipoint locking
BSA Awards	British Standard Kitemarked system: KM 530838 PAS 24:2012

Dimensions

Frame Width	53mm
Frame Depth	100mm
Glass	38mm double or triple glazed sealed units

Design Limitations

Max Sash Weight	250kg
Max Sash Height	2500mm
Max Sash Width	Within above limitations

*Auto slide opening mechanisms sold separately

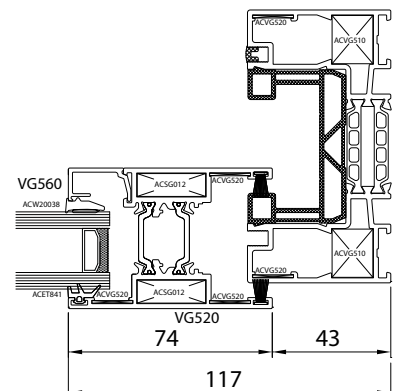
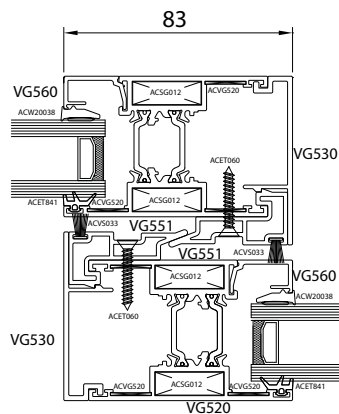
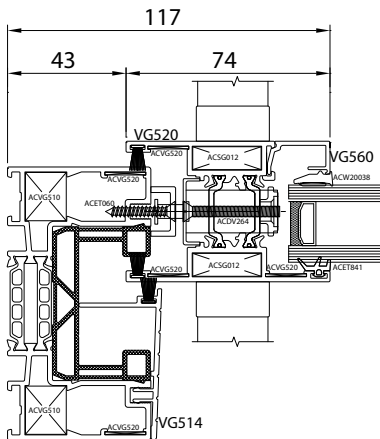
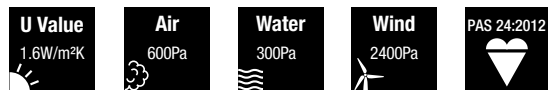

Smart Systems Limited

Arnolds Way | Yatton | Bristol | North Somerset | BS49 4QN | UK
T +44 (0) 1934 876 100 | **F** +44 (0) 1934 835 169 |
W www.smartsystems.co.uk | **E** sales@smartsystems.co.uk
 IMS129VGP.201801

The images, drawings and data shown in this brochure are for illustrative purposes only and are not binding in detail, colour or specification. We reserve the right to make changes to the product specification as technical developments dictate and without prior notice. We recommend that the user ensures that they are satisfied the product meets their requirements prior to purchase. ©Smart Systems Ltd 2015